

## Instructions

1. The examination is of 3 hours duration. The Question paper contains two parts, **PART A** and **PART B**. There are a total of 50 questions in PART A and 5 questions in PART B. Duration of Part A is **One Hour**, and duration for Part B is **Two Hours**.
2. Answers to Part A have to be entered in the computer. Answers to Part B have to be given in the answer book provided by the invigilator. PART A contains **THREE** sections, **Section I**, **Section II** and **Section III**.
3. PART A, **Section I** (Q.1 – Q.5, total 10 marks) contains a total of 5 Numerical Answer Type (NAT) questions. For these NAT type questions, the answer is a number that needs to be entered using the virtual keyboard on the monitor. No choices will be shown for these questions. There is NEGATIVE marking for this section. Each correct answer will be awarded 2 marks and each wrong answer will be awarded –0.6 marks. Questions not attempted will result in zero mark.
4. PART A, **Section II** (Q.6 – Q.15, total 20 marks) contains a total of 10 Multiple Select Questions (MSQ). Each MSQ type question has **one or more correct answer(s)** out of the four given choices. The candidate gets 2 marks **only if** s/he selects all the correct answers. There is NO NEGATIVE or PARTIAL marking for this section.
5. PART A, **Section III** (Q.16 – Q.50, total 70 marks) contains a total of 35 Multiple Choice Questions (MCQ). Each MCQ type question has four choices out of which **only one** is the correct answer. There is NEGATIVE marking for this section. Each correct answer will be awarded 2 marks and each wrong answer will be awarded –0.6 marks. Questions not attempted will be given zero marks.
6. Charts, graph sheets, tables, cellular phone or other electronic gadgets are NOT allowed in the examination hall.
7. A Scribble Pad will be provided for rough work.
8. Specific instructions to Part B are given in the answer book.

**PART A, Section I**  
**NUMERICAL ANSWER TYPE (NAT)**

Question numbers 1 – 5 carry two marks each. Correct Answer: 2 Marks, Wrong Answer: -0.6

**Question no. 1**

Alakhnanda walks 37 kms in an approximate South-West direction from her home to reach her school. She walks around 13 kms in an approximate South-East direction from her home to reach the post office. The market is 35 kms exactly East of her school. If she walks straight North from the market she reaches her home. If she walks east from the market, she reaches the post office. How much distance would she travel if she had to go from her school to the post office?

**Question no. 2**

A solid cube, 8 inches x 8 inches x 8 inches is painted red on all the faces. The cube is then sliced into smaller equal sized cubes of 1 inch x 1 inch x 1 inch. How many of these small cubes will have exactly two red faces?

**Question no. 3**

How many surfaces are present in the given regular solid?

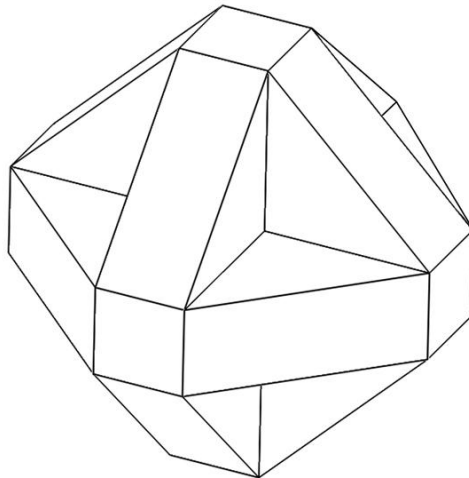

**Question no. 4**

In the given number series: 12, 24, 21, 42, 39, 78 ...

Which number would come next?

**Question no. 5**

Count the number of cubes in the following geometrically symmetric regular solid.

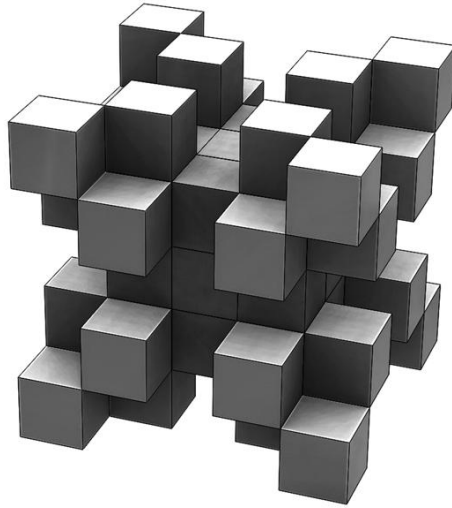

**PART A, Section II**  
**MULTIPLE SELECT QUESTIONS (MSQ)**

Question numbers 6 –15 carry two marks each. All Correct Answers: 2 Marks, No Negative or Partial Marks.

**Question no. 6**

Given below are two statements, based on which some conclusions have been drawn. If the statements are true, which of the conclusion(s) can be said to be true?

Statement 1: All mammals are fish.

Statement 2: All fish are dolphins.

- a) Some of the fish are mammals
- b) None of the dolphins are mammals
- c) Some of the mammals are dolphins
- d) All mammals are dolphins

**Question no. 7**

Among the following, select the shades of the colour red.

- a) Crimson
- b) Azure
- c) Carmine
- d) Viridian

**Question no. 8**

Which are the following vehicle(s) have a rear engine.

- a) Tata Nano
- b) Maruti Ertiga
- c) Skoda Octavia
- d) Tata Indica

**Question no. 9**

Identify the odd letter(s) which do not share the same font with any others.

# Madgels

- a) M
- b) a
- c) e
- d) s

**Question no. 10**

Which of the following films have been directed by Steven Spielberg?

- a) Indiana Jones and the Temple of Doom
- b) Saving Private Ryan
- c) Schindler's List
- d) Munich

**Question no. 11**

Which of the following artwork(s) were made by Picasso?

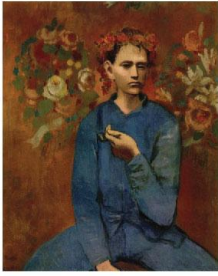

A

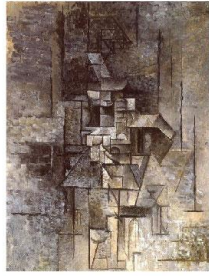

B



C



D

- a) A
- b) B
- c) C
- d) D

**Question no. 12**

Which shape(s) fit this incomplete jigsaw?

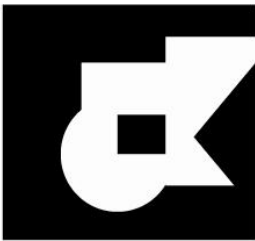
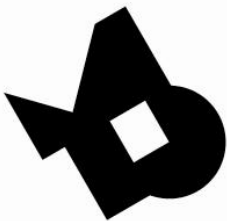

Image 1



A



B

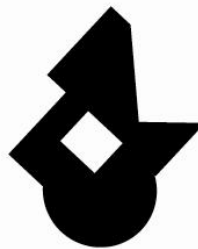

C



D

- a) A
- b) B
- c) C

d) D

**Question no. 13**

Which among the following are weights in a font family?

- a. Hairline
- b. Bold
- c. Feather
- d. Grey

**Question no. 14**

Identify the terms used in photography

- a. Depth of field
- b. ISO
- c. Jiggering
- d. Dodging

**Question no. 15**

Which of the following materials are used to make a Tetra Pak?

- a. Paper
- b. Aluminum
- c. Plastic
- d. Teflon

**PART A, Section III**  
**MULTIPLE CHOICE QUESTIONS (MCQ)**

Question numbers 16 – 50 carry two marks each. Correct Answer: 2 Marks, Wrong Answer: -0.6

**Question no. 16**

Shown here are different views of the same cube. Based on this information which colour will be on the opposite face of black?

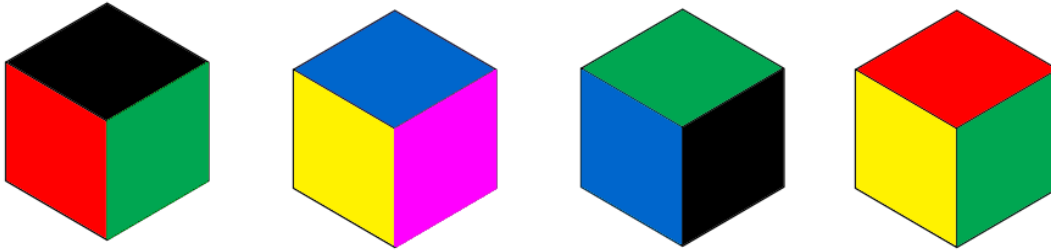

- a) Red
- b) Yellow
- c) Blue
- d) Magenta

**Question no. 17**

In a particular code language, the following words are associated with other words as follows:

wiggesslorm means flatpen

widdlebrap means roundnib

slormwiggel means penink

Given this information, which word would mean 'nibstore'?

- a) brapdansa
- b) wiggelslorm
- c) slormbrap
- d) brapwiggel

**Question no. 18**

Shown below is a straight line drawn with a particular nib. If a circle was drawn with the same nib without changing the angle, how would it look?





A



B

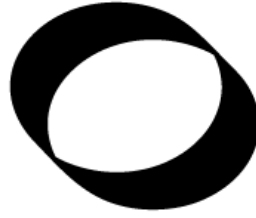

C



D

- a) A
- b) B
- c) C
- d) D

**Question no. 19**

What is the correct chronological order of the given Art movements?

- a) Realism, Renaissance, Baroque, Cubism
- b) Renaissance, Baroque, Cubism, Realism
- c) Baroque, Renaissance, Cubism, Realism
- d) Renaissance, Baroque, Realism, Cubism

**Question no. 20**

If Cyan-0%, Magenta-100%, Yellow-100%, and Black-0% are used in a conventional four colour printing process, which would be the resulting colour?

- a) Blue
- b) Violet
- c) Red
- d) Burgundy

**Question no. 21**

An inscription was found in a cave in India. When it was translated it read as follows:

Salutation to the Arhats (Jinas)... by illustrious Kharavela, the Aira, the great king, the descendant of Mahameghavahana, increasing the glory of the Chedi dynasty, overlord of Kalinga, endowed with excellent and auspicious marks and features, possessed of virtues that have reached the four quarters.



Based on these contents, where in India do you think the cave is?

- a) North India
- b) West and Central India
- c) East and North East India
- d) South India

**Question no. 22**

Which of the following is a correct bicycle frame?

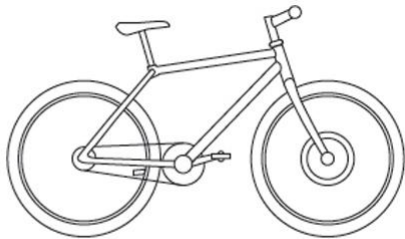

A

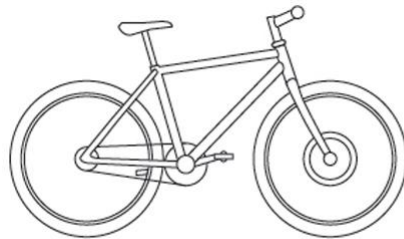

B

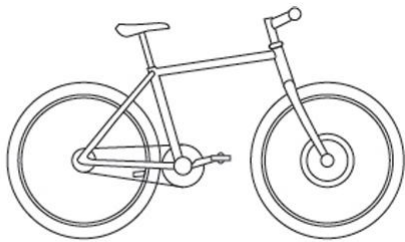

C

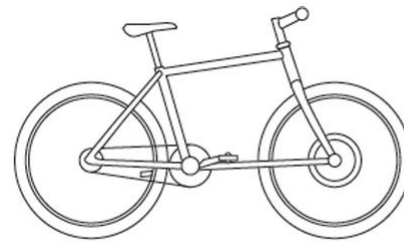

D

- a) A
- b) B
- c) C
- d) D

**Question no. 23**

Which process is used to manufacture polythene bags?

- a) Injection Moulding
- b) Blown-film Extrusion
- c) Vacuum Forming
- d) Compression Moulding

**Question no. 24**

Identify the dance form.



- a) Manipuri
- b) Odissi
- c) Kuchipudi
- d) Kathakali

**Question no. 25**

Who is the author of the book "The Accidental Prime Minister"?

- a) Natwar Singh
- b) Vinay Ahuja
- c) Sanjaya Baru
- d) Khushwant Singh

**Question no. 26**

Which organization is the symbol given below associated with?



- a) National Literacy Mission
- b) Indian Institute of Technology Hyderabad
- c) India Book House
- d) Indian Institute of Management Bangalore

**Question no. 27**

Identify the musician pictured below:

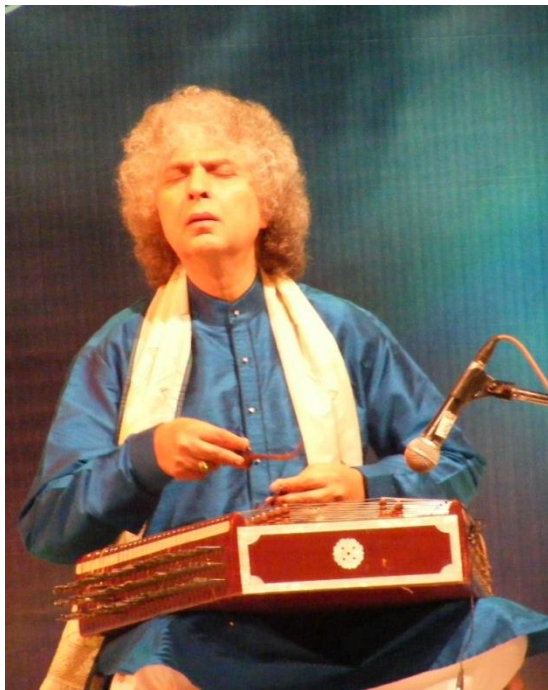

- a) Pandit Shivkumar Sharma
- b) Pandit Vishwamohan Bhatt
- c) Pandit Hariprasad Chaurasia
- d) Pandit Bhajan Sopori

**Question no. 28**

Which square contains the visual element shown below?

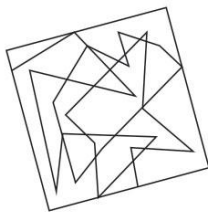

A

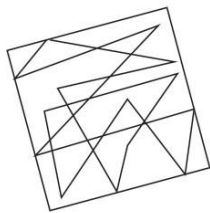

B

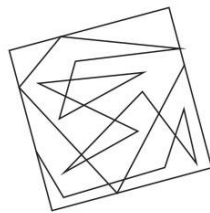

C

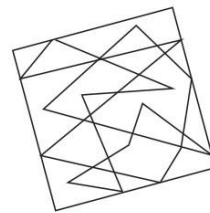

D

- a) A
- b) B
- c) C
- d) D

**Question no. 29**

A polygon is mirrored five times, as shown below. Which of the following will be the image seen in the last polygon?

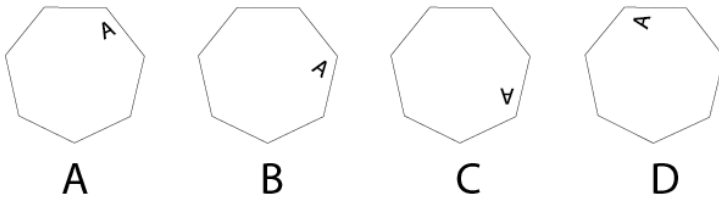

- a) A
- b) B
- c) C
- d) D

**Question no. 30**

The image shown below has been drawn in one-point perspective. Find the object which does not fit in the perspective.

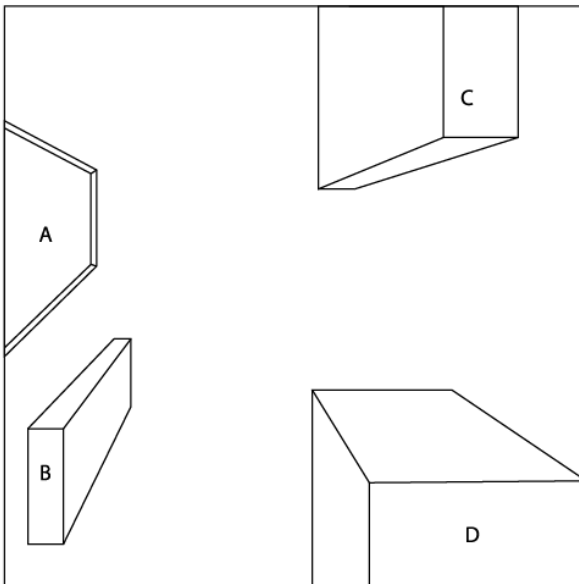

- e) A
- f) B

- g) C
- h) D

**Question no. 31**

The side view of an arm bent at the elbow is shown below. If this arm is turned towards you, which of the drawings shown will be most correct?

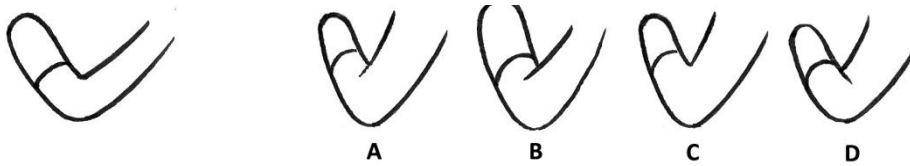

- a) A
- b) B
- c) C
- d) D

**Question no. 32**

Two positions of a person walking away from the camera are shown. Identify the position midway between these two.

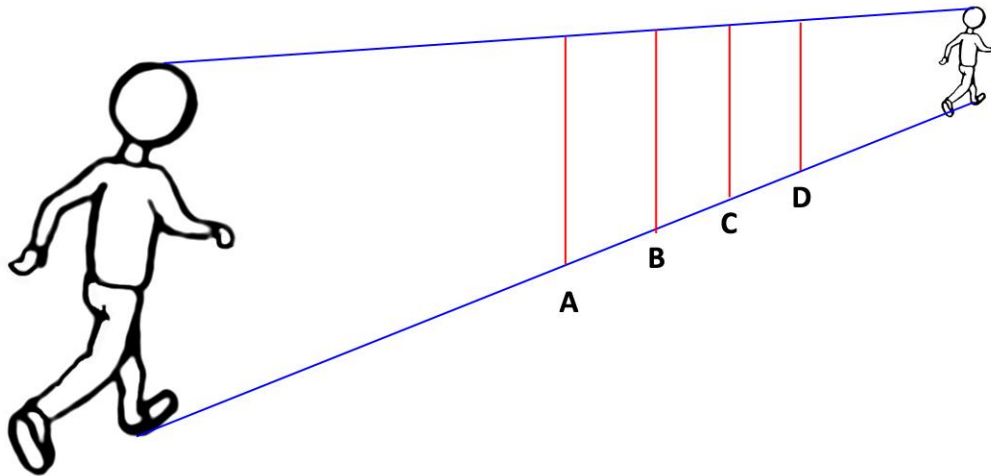

- a) A
- b) B
- c) C
- d) D

**Question no. 33**

A sequence of a superhero jumping is shown below. Identify the shape of the cape in the middle figure.

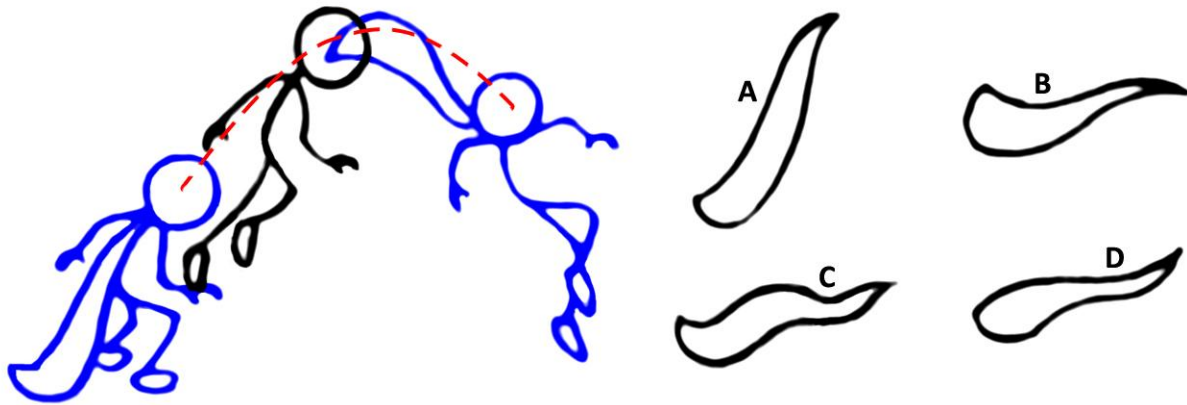

- a) A
- b) B
- c) C
- d) D

**Question no. 34**

The given solid is part of a complete cube. From the options below, which solid would complete the cube upon joining?

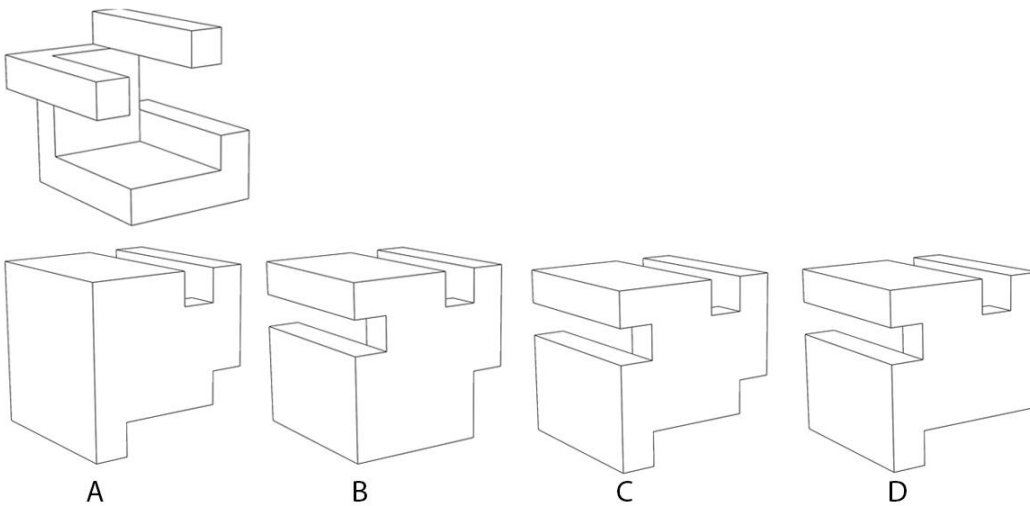

- a) A
- b) B
- c) C
- d) D

**Question no. 35**

For the given solid, identify the correct top view.

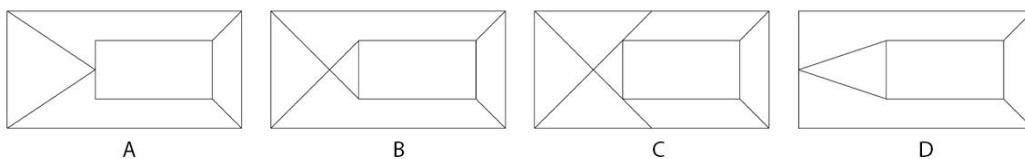
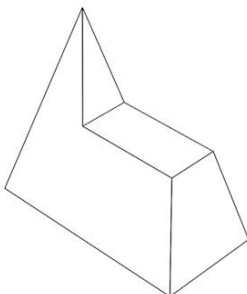

- a) A
- b) B
- c) C
- d) D

**Question no. 36**

From the given top view, choose the correct front view.

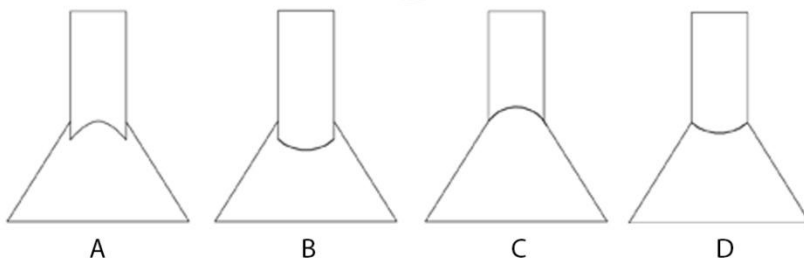
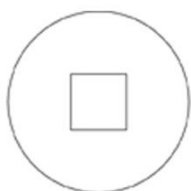

- a) A
- b) B
- c) C



d) D

**Question no. 37**

Five blocks are placed one above another in a particular sequence (as shown in figure). If a sixth block is added to the same sequence, which would be the correct top view?

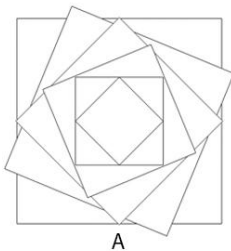
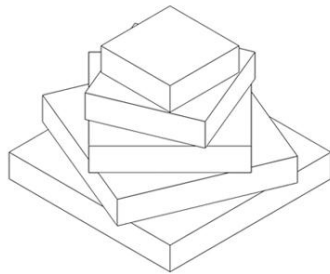

A

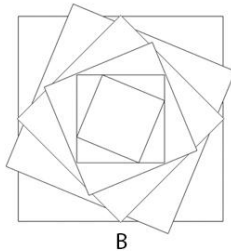

B

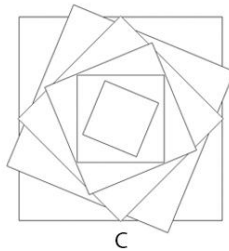

C

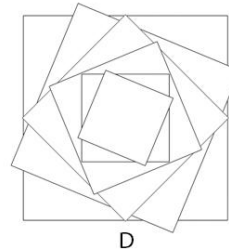

D

- a) A
- b) B
- c) C
- d) D

**Question no. 38**

Image 1 has been rotated. Which of the options given below is the same as Image 1?

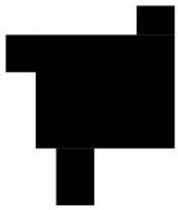
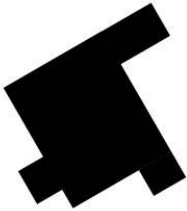
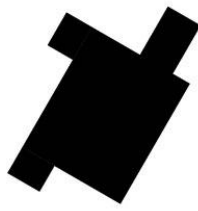

Image 1



A



B

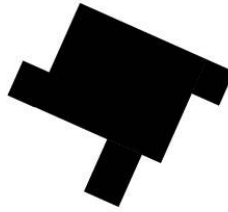

C

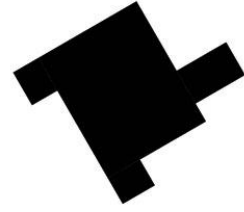

D

- a) A
- b) B
- c) C
- d) D

**Question no. 39**

Zeer is a pot-in-pot refrigerator used in the desert climate of Egypt. A small earthen pot is kept inside a larger pot. The larger pot is filled with wet sand which, over time, cools the smaller earthen pot inside. How does cooling occur in this product?

- a) Coolant induced cooling
- b) Evaporative cooling
- c) Pressure cooling
- d) Sandblast cooling

**Question no. 40**

In which region is the Hemis festival celebrated?

- a) Meghalaya
- b) Ladakh
- c) Gangtok
- d) Kutch

**Question no. 41**

Who is the author of the book 'Design of Everyday Things'?

- a) Phillipe Starck
- b) Issac Waterson
- c) Donald Norman
- d) Karim Rashid

**Question no. 42**

A square sheet of paper is folded twice and cut in the manner shown in Image 1. After cutting, the black part is removed. When the cut paper is unfolded, which pattern will it form?

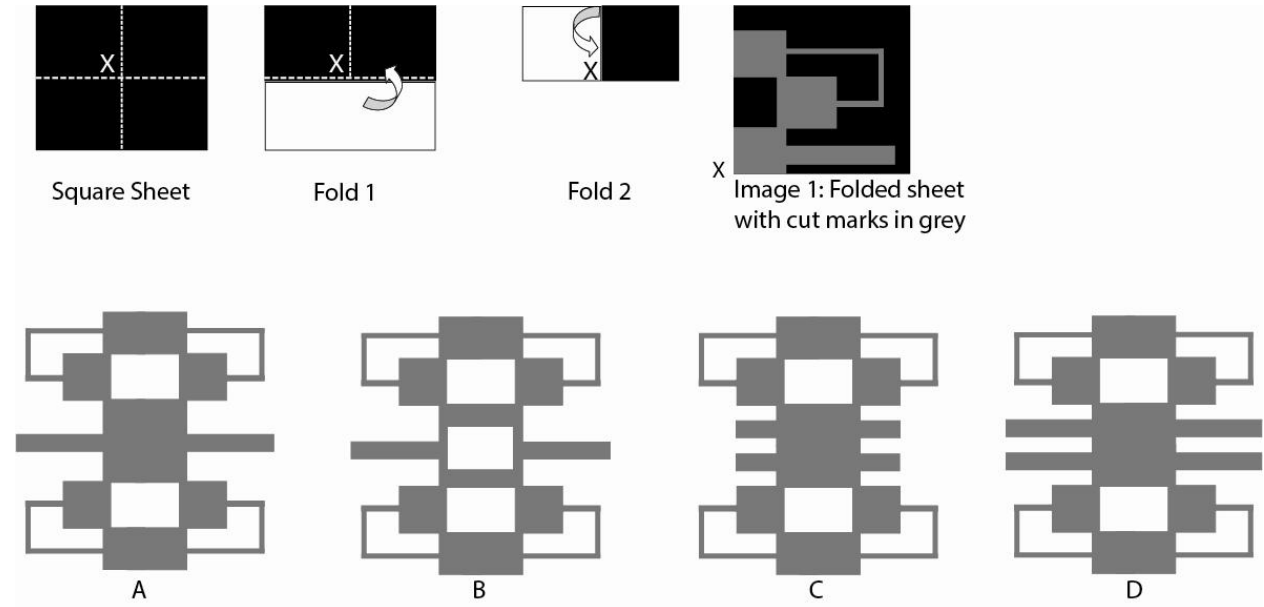

- a) A
- b) B
- c) C
- d) D

**Question no. 43**

Who among the following is NOT a Poet?

- a) Magha
- b) Bharavi
- c) Brahmagupta
- d) Kalidasa

**Question no. 44**

What is the commercial name of expanded polystyrene?

- a) Thermocol
- b) Teflon

- c) Nylon
- d) Lycra

**Question no. 45**

Identify the symbol shown below.



- a) Right to Information
- b) Right to Education
- c) Right to Literacy
- d) Right to Investment

**Question no. 46**

In which context is the term “Pica” system used?

- a) Plastic Moulding
- b) Image editing
- c) Typography
- d) Sculpture

**Question no. 47**

Identify the odd one out

- a) Verdana
- b) Tahoma
- c) Cambria
- d) Calibri

**Question no. 48**

A double layered cone of a sheet has three triangular holes punched in it, as shown below. When the cone is unrolled, which of the following is the correct development?

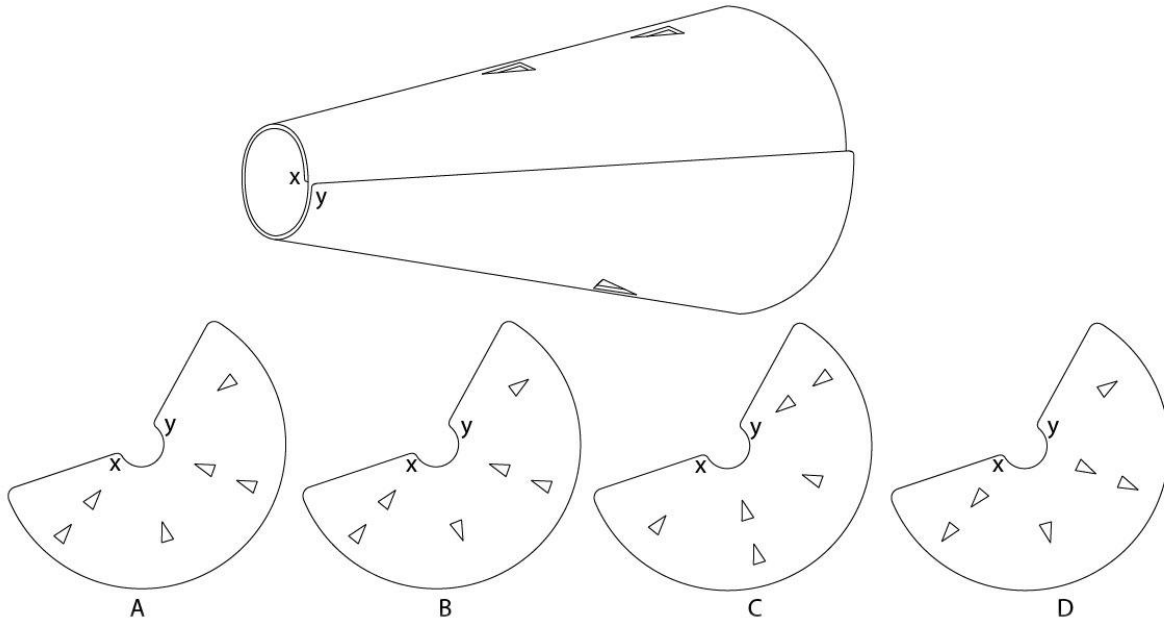

- a) A
- b) B
- c) C
- d) D

**Question no. 49**

How many fonts have been used to write the following set of words?

hore pad rits zlob sert clert jups lits

- a) Three
- b) Four
- c) Five
- d) Two

**Question no. 50**

If the state of Uttar Pradesh is divided into four states, how many states would India have?

- a) 33
- b) 32

- c) 31
- d) 34

## PART B

**Questions 1 to 4 are mandatory. Attempt any ONE from questions 5a to 5d**

### Question No. 1

**Marks 20**

Imagine a scene from a cookery show. The chef has just placed a pressure cooker on a two-burner gas stove. Draw a **freehand** perspective drawing of this setup.

#### Note:

- Use only pencils
- Do not use any drawing instruments, such as ruler, compass, set-square or anything else.
- Do not use any kind of colour

Pay attention to perspective, light, shade and shadow, quality of lines, as well as scale and proportion in the composition.

### Question No. 2

**Marks 10**

Imagine that you are given a hand held magic device, which can reduce the size of any object by 50%. The reduction in size will remain effective for only three hours. To reduce the size, point the device toward an object and press the button. **Illustrate two creative applications** of this device. If required, support each application with a brief note of no more than 50 words each.

Pay attention to variety, creativity, as well as innovation in the concepts.

### Question No. 3

**Marks 12**

The following objects are available to you –

**1 Cone, 1 Hemisphere, 1 Cuboid, 1 Cylinder and 1 Disc** as shown below:

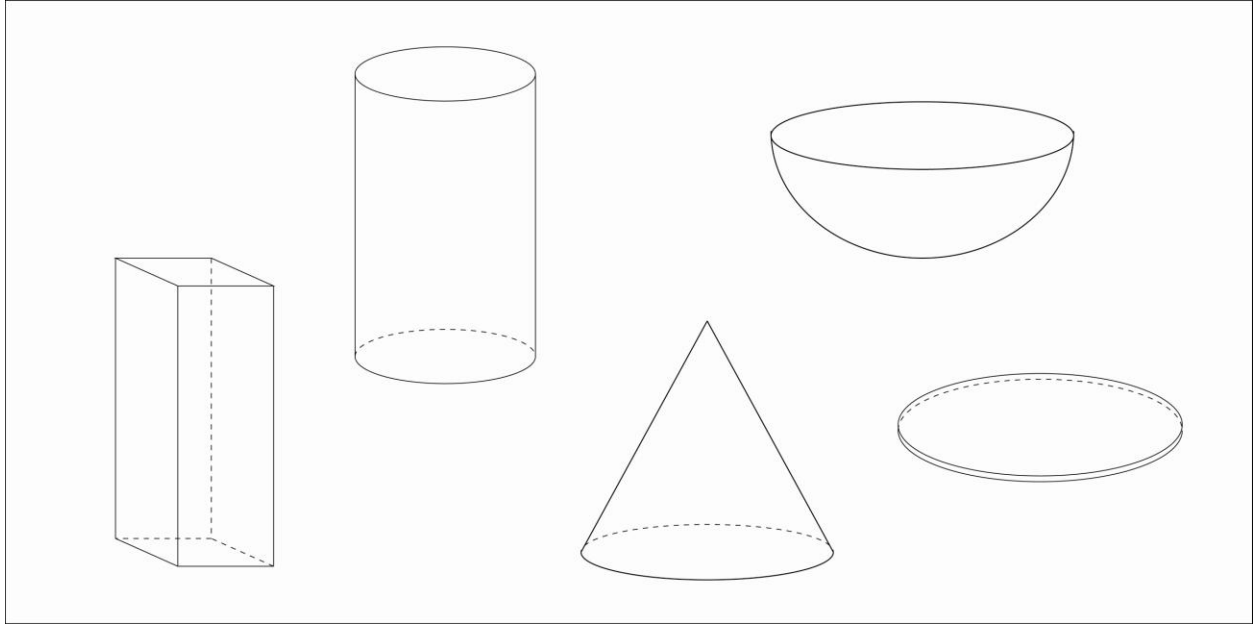

Imagine **3 interesting products** made out of a combination of **of minimum 3 objects**. You can scale the objects to any size and dimension.

Represent your ideas with **neat sketches** and **name** them in the space provided.

Pay attention to variety, creativity, as well as innovation in the concepts.

**Question No. 4**

**Marks 8**

Construct two different stories from a combination of these 3 words:**Cobbler, Football and Footpath**. **The story should be no longer than three sentences.**(A cobbler is a person who repairs footwear, umbrellas, etc.)

One possible story could be this:

A child cries. The cobbler on the footpath repairs the child’s football. The child smiles.

Pay attention to variety and creativity in the plots.



**Optional Question: (50 Marks). ANSWER ANY ONE from questions 5a to 5d.**

### **Question 5a: Optional (Product Design)**

Women in rural India have to walk a long distance to carry three to four pots filled with drinking water to their homes. This causes a lot of physical strain.

*Design a device to help women **carry four earthen pots** of drinking water through uneven terrain. Identify at least **five** distinct factors essential in this device that will make it relevant for rural India.*

Present your design proposal with

- A neat free hand sketch showing the overall form and its features
- Sketches illustrating the usage scenario
- Indicators of materials and processes used in manufacturing
- A brief note on design decisions taken (max 100 words)

Pay attention to user centric design considerations, feasibility and overall effectiveness of design solutions, appropriateness of materials to be used in the manufacturing, originality of concepts as well as quality of presentation.

### **Question 5b: Optional (Interaction Design)**

An organization has decided to develop an interactive pencil box (a box in which students carry pen, pencils, eraser, ruler etc.) for students of standard 7-10 (approximate age group 12-15 years). The organization hopes that the interactive device would act as a learning aid both inside and outside the classroom for students.

Design the interactive pencil box, and illustrate how it will be used by students.

- a. Visualize the 3D form of the device along with its graphical interface. The visual design and form of the device should appeal to students of this age group. Present this in the form of **sketches/drawings** in the space provided.
- b. State three or more 'original and innovative' **features of the device** which will assist students in their studies. DO NOT describe features available in present day smart devices (e.g. calculator, dictionary, e-book reader etc.). Describe the features with neat sketches and explanatory notes.
- c. **Illustrate in detail** one of the above concepts. Explain how the device would assist students in learning a topic related to the **history of India**. Present the interface and information flow of the device, and describe along with visuals, the set of interactions that will be presented to the student during the complete learning cycle.

Pay attention to logic and flow in the Interface, usability and appropriateness of the information, originality of concepts and overall effectiveness of the design as well as quality of presentation.

## Question 5c: Optional (Animation Design)

An animation film for 5 to 12 year old children is in pre-production stage. The film is based on the relationship between a kid (girl/boy) and his/her puppy. This is a shot breakdown of a sequence from the film.

Shot 1. A 10 year old kid (girl/boy) and his puppy are playing with a ball in a field.

Shot 2. Suddenly s/he notices a huge eagle swooping down on the puppy.

Shot 3. The eagle reaches out with its talons (claws), grabs the puppy and flies off.

Shot 4. The kid sees the puppy carried away.

Shot 5. The kid picks up the ball and throws it at the eagle

Shot 6. The ball hits the eagle, and he drops the puppy.

Shot 7. The girl/boy is reunited with the puppy, hugs him.

### Part 1

Illustrate (Create a Storyboard of) the above shots as a series of picture frames. You can use more than one frame per shot if you want. Approximate shape of the frame is shown below. You can choose to make the drawing and then draw the frame on top of it to compose your shot or you can create the frame and then draw inside.

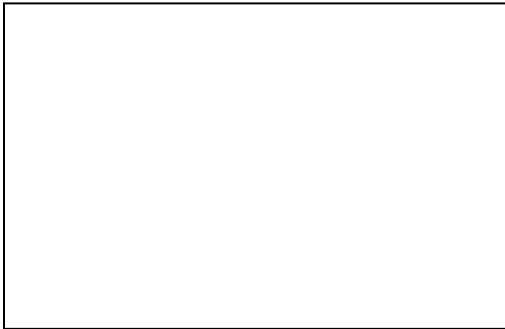

### Part 2

Draw shot 3 (the eagle reaching out, about to grab the puppy) in detail in a style which is one of the following. Line drawing is sufficient. Detailed rendering and shading can be done if needed.

- a. Realistic
- b. Stylised

In part 1, pay attention to communication of the narrative through sequential pictures and shot composition.

In part 2, pay attention to illustration skills, composition and perspective (if realistic style chosen) or Illustration style (if stylized chosen.)

### **Question 5d: Optional (Visual Communication)**

Indian government is initiating a safety and awareness campaign for preventing accidents at home called '*Suraksha*' (Safety). '*Suraksha*' aims at bringing awareness amongst citizens regarding safety with household appliances. Support the campaign by designing a section of the information booklet on gas cylinders. Complete the following tasks for the same.

- a. Design a logo for the campaign title '*Suraksha*'.
- b. Identify four problems that users face while changing domestic gas cylinders. Illustrate the problems in thumbnail sketches.
- c. Show three different illustration styles for visually representing one of the problems stated by you earlier. Create three thumbnail sketches to represent your ideas.
- d. Design a layout of the information booklet in neat pencil sketches. Size of the booklet is 6 x 6 inches. Depict the final illustration/s and its sequence keeping in mind problems in comprehension as well as safety hazards involved in handling gas cylinders. Use text minimally or preferably not at all. Select appropriate views and representation styles to illustrate objects as well as actions.

Pay attention to the quality of visual renderings, appropriate selection of views of the object and actions, effectiveness of presentation in minimal space, and elements and clarity in the structure and sequencing of information.